

RESOL DeltaSol[®] BS

Mounting

Connection

Operation

Troubleshooting

Examples



DeltaSol[®] BS



manual

www.resol.de



48003590

**Thank you for buying this RESOL product.
Read this manual carefully to get the best performance from this unit.**

Safety advice

Please pay attention to the following safety advice in order to avoid danger and damage to people and property.

Instructions:

Attention should be paid to

- valid local regulations
- the statutory provisions for prevention of industrial accidents,
- the statutory provisions for environmental protection,
- the Health and Safety at Work Act 1974
- Part P of the Building Regulations 2005
- BS7671 Requirements for electrical installations and relevant safety regulations of DIN, EN, DVGW, TRGI, TRF and VDE.

These instructions are exclusively addressed to authorised skilled personnel.

- Only qualified electricians should carry out installation and maintenance work.
- Initial installation should be carried out by named qualified personnel

Appropriate usage

This product is to be used in solar thermal systems in compliance with the technical data specified in these instructions.

Improper use excludes all liability claims

Subject to change without prior notice. Errors excepted

Table of contents

Safety instructions.....	2
Technical data and overview of functions.....	3
1. Installation.....	5
1.1 Mounting.....	5
1.2 Electrical wiring.....	5
1.2.1 Data communication / Bus.....	6
1.2.2 Standard solar system.....	7
1.2.3 Solar system and after-heating.....	7
2. Operation and function	8
2.1 Buttons for adjustment.....	8
2.2 System monitoring display	8
2.2.1 Channel display.....	8
2.2.2 Tool bar.....	8
2.2.3 System screen.....	9
2.3 Flashing codes.....	9
2.3.1 System-Screen flashing codes	9
2.3.2 LED flashing codes.....	9
3. Commissioning.....	10
4. Control parameter and display channels.....	11
4.1 Overview	11
4.1.1-5 Display channels.....	12
4.1.6-17 Adjustment channels.....	14
5. Troubleshooting.....	18
5.1 Various.....	19
6. Accessory	21
Imprint	24

Declaration of conformity

The product complies with the relevant directives and is therefore labelled with the CE mark. The Declaration of Conformity is available upon request, please contact RESOL.



- System-monitoring display
- Up to 4 temperature sensors Pt1000
- Heat quantity measurement
- RESOL VBus®
- Function control
- User-friendly operation through simple handling
- Solar operating hours counter and thermostat function

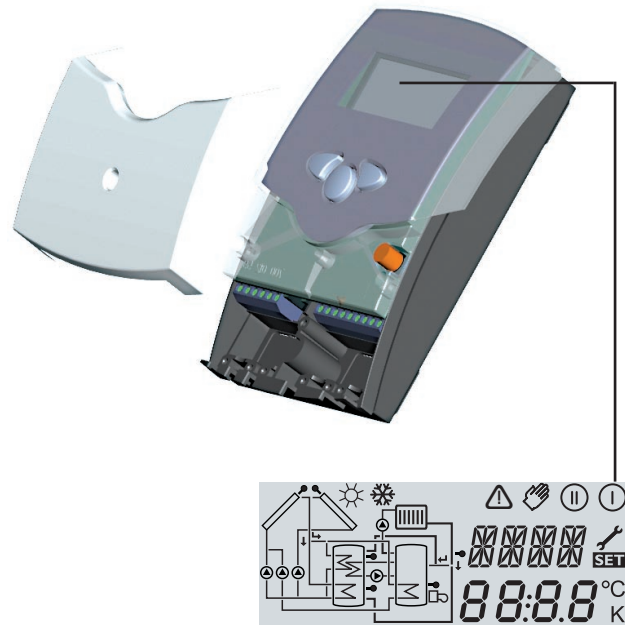

Scope of delivery:

1 x DeltaSol® BS/3

1 x accessory bag

1 x fuse T4A

2 x screws and dowels

4 x strain relief and screws

Additionally enclosed in the full kit:

1 x sensor FKP6

2 x sensor FRP6

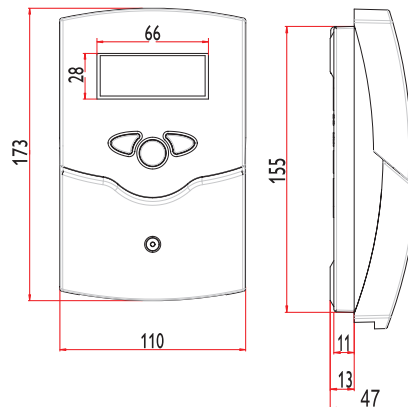

The DeltaSol® BS is a controller for standard solar thermal systems. It provides a clear operating concept and is equipped with a system-monitoring display. Flashing symbols for sensors, pumps and valves show temperatures, temperature differences and active actuators. The DeltaSol® BS controller is available in 4 versions

Technical data

Housing:

plastic, PC-ABS and PMMA

Protection type: IP 20 / DIN 40050

Ambient temp.: 0 ... 40 °C

Dimensions: 172 x 110 x 46 mm

Mounting: wall mounting, mounting into patch-panels is possible

Display: System screen for systems visualisation, 16-segment display, 7-segment display, 8 symbols for system status and operating control lamp

Operation: 3 push buttons at the front of the housing

Functions: Differential temperature controller with optional system functions. Function control according to BAW-guidelines, operating hours counter for solar pump, tube collector function as well as heat quantity measurement.

Inputs:

for 4 temperature sensors Pt1000

Outputs: 2 standard relays

Bus: RESOL VBus®

Power supply:

220 ... 240 V~

Mode of operation:

Type 1.b

Switching capacity

electromechanical relay:

2 (1) A (220 ... 240) V~



Examples DeltaSol® BS

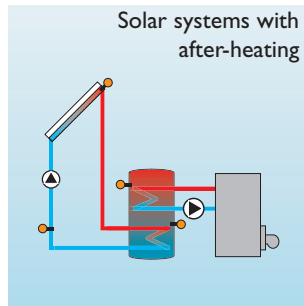
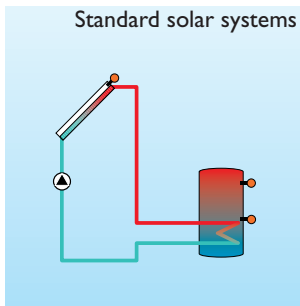

For detailed connection diagrams see chapter 1.



Order note

- **Version BS1 2.00: 1 standard relay, operating hours counter**

RESOL DeltaSol® BS/1 115 412 13

RESOL DeltaSol® BS/1 - full kit 115 412 23

incl. 3 temperature sensors Pt1000 (1 x FKP6, 2 x FRP6) 115 412 23

RESOL DeltaSol® BS/1 - full kit 115 412 53

incl. SD3 and 3 sensors Pt1000 (1 x FKP6, 2 x FRP6)
- **Version BS2 2.00: 1 semiconductor relay, speed control, operating hours counter**

RESOL DeltaSol® BS/2 115 412 33

RESOL DeltaSol® BS/2 - full kit 115 412 43

incl. 3 temperature sensors Pt1000 (1 x FKP6, 2 x FRP6) 115 412 43

RESOL DeltaSol® BS/2 - full kit 115 412 63

incl. SD3 and 3 sensors Pt1000 (1 x FKP6, 2 x FRP6)
- **Version BS3 2.00: 2 standard relay, thermostat function, operating hours counter**

RESOL DeltaSol® BS/3 115 424 93

RESOL DeltaSol® BS/3 - full kit 115 425 03

incl. 3 temperature sensors Pt1000 (1 x FKP6, 2 x FRP6) 115 425 03

RESOL DeltaSol® BS/3 - full kit 115 425 33

incl. SD3 and 3 sensors Pt1000 (1 x FKP6, 2 x FRP6)
- **Version BS4 2.00: 1 standard relay, 1 standard relay, speed control, operating hours counter, thermostat function**

RESOL DeltaSol® BS/4 115 425 13

RESOL DeltaSol® BS/4 - full kit 115 425 23

incl. 3 temperature sensors Pt1000 (1 x FKP6, 2 x FRP6) 115 425 23

RESOL DeltaSol® BS/4 - full kit 115 425 43

incl. SD3 and 3 sensors Pt1000 (1 x FKP6, 2 x FRP6)

1. Installation

1.1 Mounting

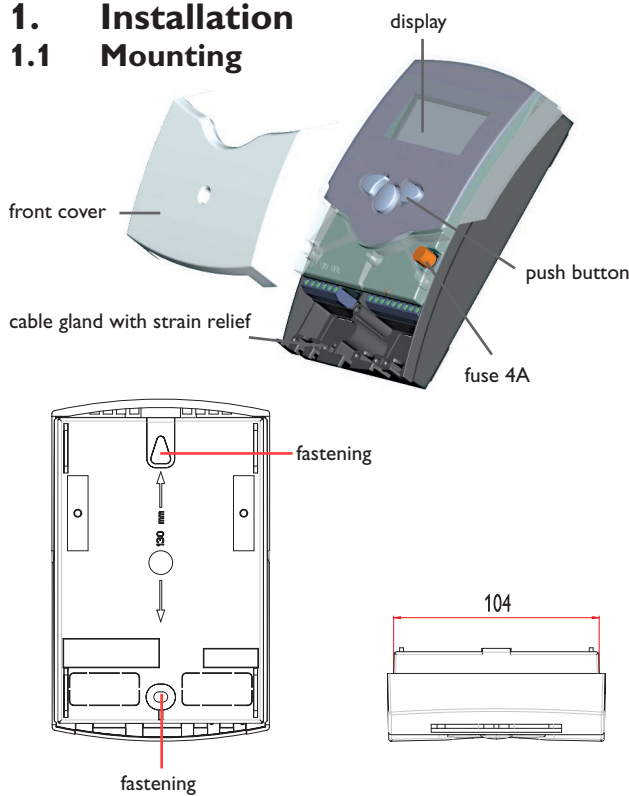

WARNING!
Always switch-off power supply and disconnect the controller from the mains before opening the housing!

The unit must only be located in dry interior locations. It is not suitable for installation in hazardous locations and should not be placed close to any electromagnetic fields. The controller must additionally be supplied from a double-pole switch with contact gap of at least 3 mm. Please pay attention to separate routing of sensor cables and mains cables.

1. Unscrew the cross-head screw from the cover and remove it along with the cover from the housing.
2. Mark the upper fastening point on the wall and drill and fasten the enclosed wall plug and screw leaving the head protruding.
3. Hang the housing from the upper fastening point and mark the lower fastening point through the hole in the terminal box (centres 130 mm). Drill and insert the lower wall plug.
4. Fasten the housing to the wall with lower fastening screw and tighten.

1.2 Electrical connection

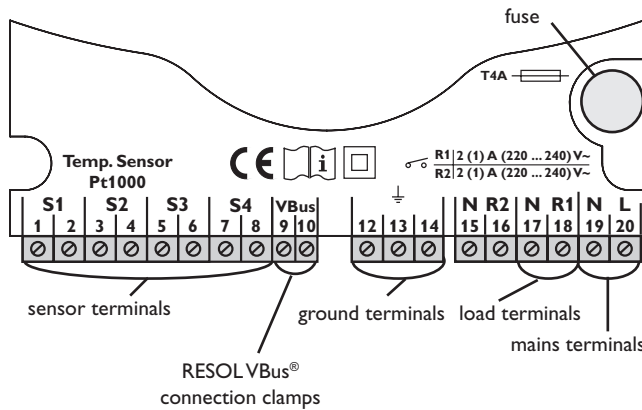

The power supply to the controller must be carried out via an external power switch (last step!) and the supply voltage must be 220 ... 240V~ (50 ... 60 Hz). Flexible cables must be attached to the housing with the enclosed strain relief and the corresponding screws.

The controller is equipped with 2 relays to which **loads** such as pumps, valves, etc. can be connected:

- Relay 1
 - 18 = conductor R1
 - 17 = neutral conductor N
 - 13 = ground clamp ⊕
- Relay 2
 - 16 = conductor R2
 - 15 = neutral conductor N
 - 14 = ground clamp ⊕

Temperature sensors (S1 to S4) have to be connected to the following terminals (either polarity):

- 1 / 2 = sensor 1 (e.g. sensor collector)
- 3 / 4 = sensor 2 (e.g. sensor store)
- 5 / 6 = sensor 3 (e.g. store top sensor)
- 7 / 8 = sensor 4 (e.g. return temperature sensor)

The **power supply connection** has to be carried out via the following terminals:

- 19 = neutral conductor N
- 20 = conductor L
- 12 = ground clamp ⊕



Electrostatic discharge can lead to damage to electronic components!



Dangerous voltage!

1.2.1 Data communication/Bus

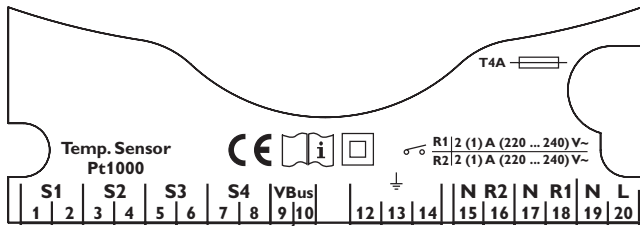

RESOL VBus®
connection clamps

The controller comes with a RESOL VBus® for data communication and energy supply of external modules. The connection is effected with optional polarity at the clamps marked with „VBus“. Via this data Bus you can install one or more RESOL VBus® modules, e.g.:

- RESOL large display GA3/SD3
- RESOL Data logger, DL2
- RESOL Data teleindication

Additionally, the controller can be connected to the PC with the help of a RESOL RS-COM adapter. With the RESOL ServiceCenter Software (RSC) the controller parameters can be changed, measurements can be read out, processed and visualised. The software enables an easy function control and adjustment of the system. A light Version of the software can be downloaded from www.resol.de for free.

1.2.2 Allocation of terminals for system 1

Standard solar system with 1 store, 1 pump and 3 sensors. The sensor S4 / TRF can be optionally used for heat quantity measurement.

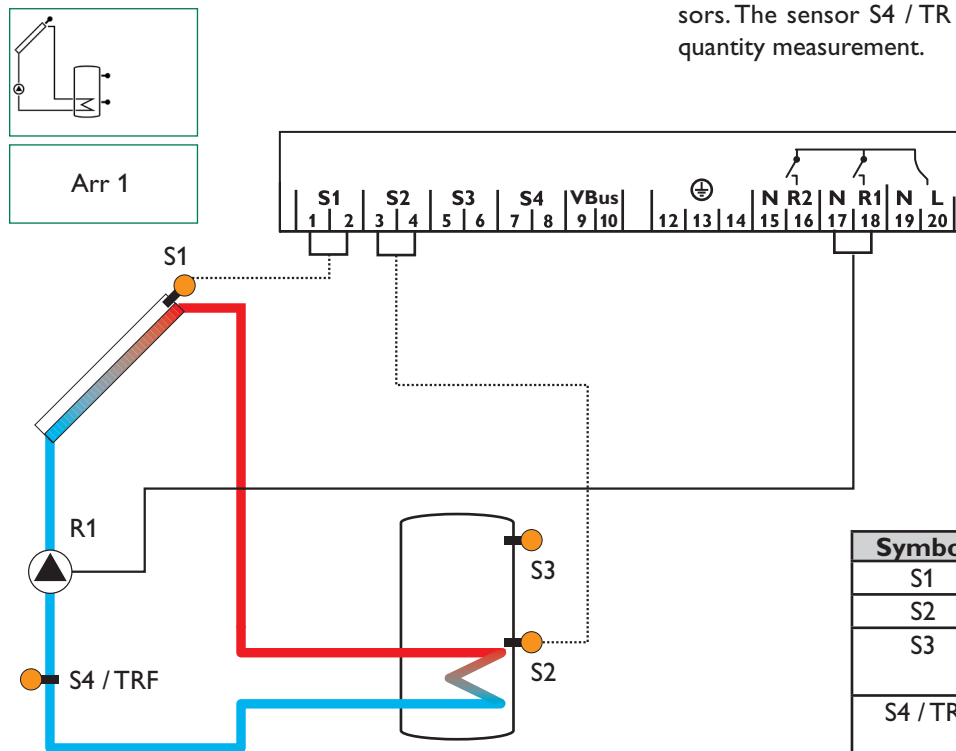

Symbol	Specification
S1	collector sensor
S2	store base sensor
S3	store top sensor; (optional)
S4 / TR	sensor for heat quantity measurement (optional)
R1	solar pump

1.2.3 Allocation of terminals for system 2

Solar system and after-heating with 1 store, 3 sensors and after-heating. The sensor S4 / TRF can be optionally used for heat quantity balancing.

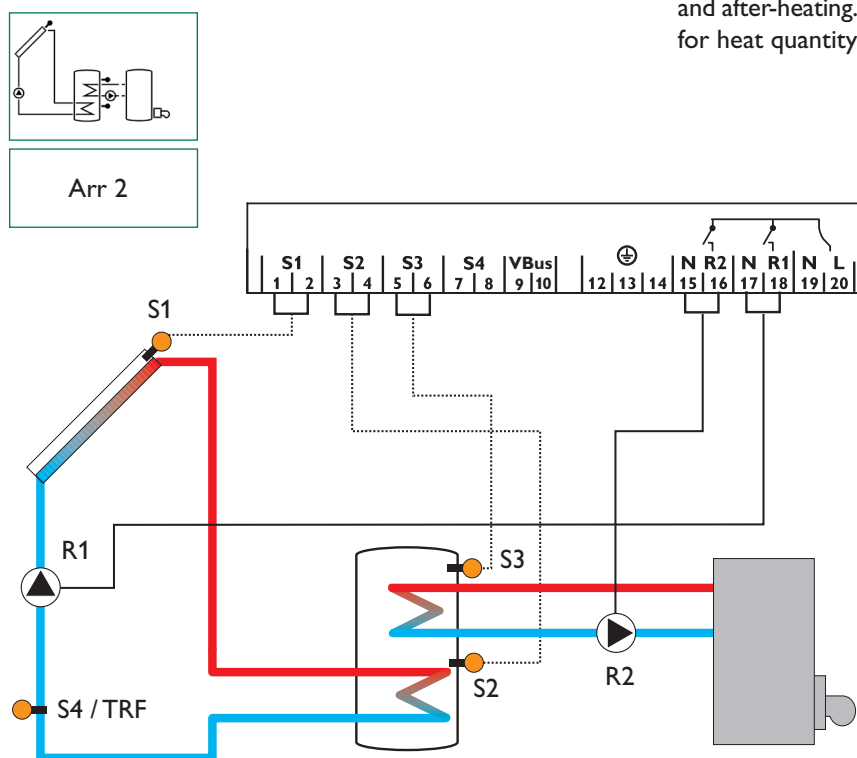

Symbol	Specification
S1	collector sensor
S2	store base sensor
S3	store top sensor
S4 / TRF	sensor for heat quantity measurement (optional)
R1	solar pump
R2	pump for afterheating

2. Operation and function

2.1 Buttons for adjustment

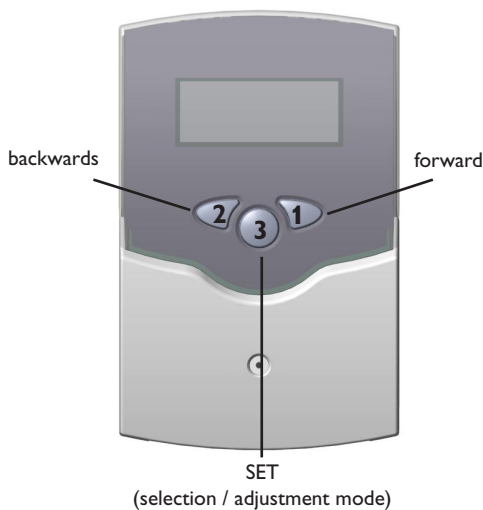

The controller is operated via the 3 push buttons below the display. The forward-button (1) is used for scrolling forward through the display menu or to increase the adjustment values. The backward-button (2) is similarly used for scrolling backwards and reducing values.

In order to access the adjustment mode, scroll down in the display menu and press the forward button (1) for approx. 3 seconds after you have reached the last display item. If an **adjustment value** is shown on the display, the „SET“ icon is displayed. Now, you can access the adjustment mode by using button 3.

- Press buttons 1 and 2 in order to select a channel
- Briefly press button 3, „SET“ will flash
- Adjust the value by pressing buttons 1 and 2
- Briefly press buttons 3, so that „SET“ permanently appears, the adjusted value will be saved.

2.2 System monitoring display

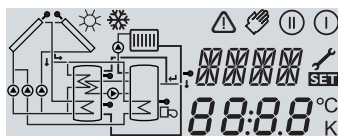

Complete Monitoring-Display

The system monitoring display consists of 3 blocks: **channel display**, **tool bar** and **system screen** (active arrangement).

2.2.1 Channel display



channel display

The **channel display** consists of two lines. The upper line is an alpha-numeric 16-segment display (text display) for displaying channel names and menu items. In the lower 7-segment display, the channel values and the adjustment parameters are displayed.

Temperatures and temperature differences are indicated in °C or K respectively.

2.2.2 Tool bar



tool bar

The additional symbols in the **tool bar** indicate the actual system status.

Symbol	standard	flashing
ⓘ	relay 1 active	
Ⓜ	relay 2 active	
☀	store maximum limitation active / maximum store temperature exceeded	collector cooling function or recooling function active
❄	antifreeze- function activated	collector minimum limitation or antifreeze function active
⚠		collector emergency shutdown or store emergency shutdown active
⚠ + 🔧		sensor defect
⚠ + 🖐		manual operation active
SET		SET-mode, change of adjustment value is possible

2.2.3 System screen

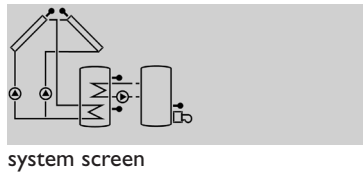

The system screen (active arrangement) shows the scheme which has been selected. The screen consists of several system component symbols, which are - depending on the current status of the system - either flashing, permanently shown or „hidden“.

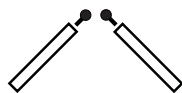
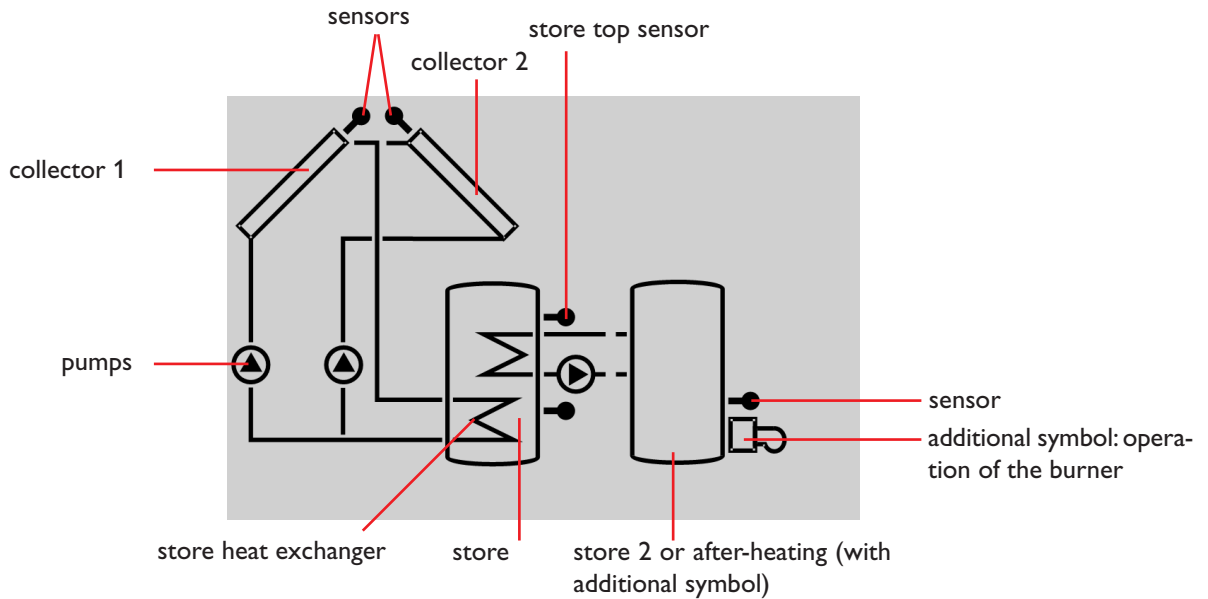

collectors
with collector sensor



store
with heat exchanger



After-heating
with burner symbol

2.3 Flashing codes

2.3.1 System screen codes

- Pump symbols are flashing during initialisation phase
- Sensor symbols are flashing if the corresponding sensor display channel is selected.
- Sensor symbols are flashing in the case of a sensor fault.
- Burner symbol is flashing if the after-heating is active

2.3.2 LED flashing codes

- green: everything OK
- red/green flashing: initialisation phase
- red flashing: sensor fault (sensor symbol is flashing quickly)
- manual operation

3. Commissioning

When the controller is commissioned for the first time, the arrangement has to be selected first

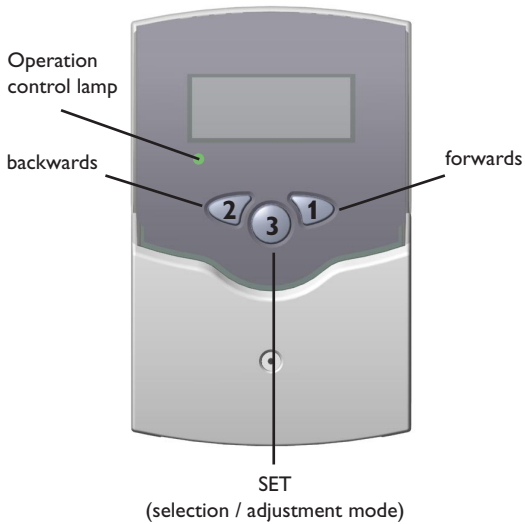

1. Switch on power supply. During the initialisation phase, the operating control lamp flashes red and green. After initialisation, the controller is in the automatic mode with typical settings. The pre-programmed system scheme is Arr 1.

2. - select adjustment channel Arr
 - change to the **SET**-mode (see 2.1)
 - select the arrangement via the Arr-index number
 - save the adjustment by pressing the **SET** button

Now the controller is ready for operation with typical settings to suit that system and normally the factory settings will give close to optimum operation.

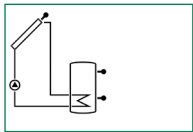

Arr 1

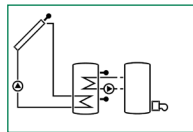

Arr 2

Overview of arrangements:

Arr 1 : standard solar system

Arr 2 : solar system with after-heating

4. Control parameters and display channels

4.1 Overview of channels

Legend:

x

Corresponding channel is available.

x*

Corresponding channel is available when the corresponding option is enabled

Please note:

Only if temperature sensors are connected, will S3 and S4 be displayed.

①

Only if the option heat quantity measurement is **activated** (OHQM), will the corresponding channel be available.

②

Only if the option heat quantity measurement is **deactivated** (OHQM), will the corresponding channel be available.

MEDT

Only if an antifreeze (MEDT) other than **water or Tyfocor® LS / G-LS (MEDT 0 or 3)** is used, will the channel antifreeze concentration (MED%) be displayed.

channel	Arr		description	page
	1	2		
COL	x	x	Temperature collector	12
TST	x		Temperature store	12
TSTL		x	Temperature store base	12
TSTU		x	Temperature store top	12
S3	x		Temperature sensor 3	12
TRF	①	①	Temperature return sensor	12
S4	②	②	Temperature sensor 4	12
h P	x		Operating hours relay 1	12
h P1		x	Operating hours relay 1	12
h P2		x	Operating hours relay 2	12
kWh	①	①	Heat quantity kWh	13
MWh	①	①	Heat quantity MWh	13
time	x		time	13
Arr	1-2		Arrangement	10
DT O	x	x	Switch-on temperature difference	14
DT F	x	x	Switch-off temperature difference	14
S MX	x	x	Maximum temperature store	14
EM	x	x	Emergency temperature collector	15

channel	Arr		description	page
	1	2		
OCX	x	x	Option collector cooling collector	15
CMX	x*	x*	Maximum temperature collector	15
OCN	x	x	Option minimum limitation collector	15
CMN	x*	x*	Minimum temperature collector	15
OCF	x	x	Option antifreeze collector	15
CFR	x*	x*	Antifreeze temperature collector	15
OREC	x	x	Option recooling	16
OTC	x	x	Option tube collector	16
AH O		x	Switch-on temp. for thermostat	17
AH F		x	Switch-off temp. for thermostat	17
t1on			Switch on time 1 thermostat	17
t1off			Switch off time 1 thermostat	17
t2on			Switch on time 2 thermostat	17
t2off			Switch off time 2 thermostat	17
t3on			Switch on time 3 thermostat	17
t3off			Switch off time 3 thermostat	17
OHQM		x	Option heat quantity measurement	13
FMAX	①	①	Maximum flowrate	13
MEDT	①	①	Antifreeze type	13
MED%	MEDT	MEDT	Antifreeze concentration	13
HND1	x	x	Manual operation relay 1	17
HND2	x	x	Manual operation relay 2	17
LANG	x	x	Language	17
BS3	X.XX		Version number	

4.1.1 Collector temperature

COL:

Collector temperature
display range: -40...+250 °C



Display of the current collector temperature.

- COL : collector temperature (1-collector system)

4.1.2 Store temperatures

TST,TSTL,TSTU:

Store temperatures
Display range: -40...+250 °C

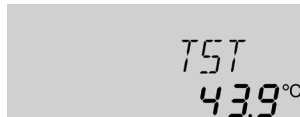

Display of the current store temperature.

- TST : store temperature (1-store system)
- TSTL : store base temperature,
- TSTU : store top temperature

4.1.3 Sensor 3 and sensor 4

S3, S4:

Temperatures at the sensors
S3 and S4
Display range: -40...+250 °C

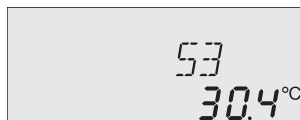

Display of the current temperature at the corresponding additional sensor (without control function).

- S3 : temperature - sensor 3
- S4 : temperature - sensor 4

Please note:

Only if the temperature sensors are connected (displayed), will S3 and S4 be displayed.

4.1.4 Time

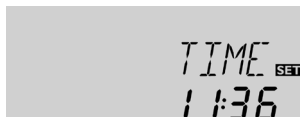

In this channel the current time is indicated.

By pressing button **SET** for 2 seconds the hours, by pressing it again the minutes are displayed blinking. The time can be set by buttons 1 and 2 and saved by pressing the **SET** button.

4.1.5 Other temperatures

TRF:

other measured temperatures
Display range: -40...+250 °C



Display of the current temperature at the sensor.

- TR : temperature - return

4.1.6 Operating hours counter

h P / h P1 / h P2:

Operating hours counter
Display channel

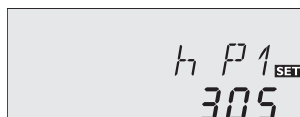

The operating hours counter accumulates the solar operating hours of the respective relay (**h P / h P1 / h P2**). Full hours are displayed.

The accumulated operating hours can be set back to zero. As soon as one operating hours channel is selected, the symbol **SET** is displayed. Press the SET (3) button for approx. 2 seconds in order to access the RESET-mode of the counter. The display symbol **SET** will flash and the operating hours will be set to 0. Confirm the reset with the **SET** button in order to finish the reset.

In order to interrupt the RESET-process, do not press a button for about 5 seconds. The display returns to the display mode.

4.1.7 Heat quantity measurement option

OHQM: Heat quantity measurement

Adjustment range: OFF...ON

Factory setting: OFF



FMAX:

Flow rate in l/min

Adjustment range 0... 20
in 0,1-steps

Factory setting: 6,0



MEDT: Antifreeze type

Adjustment range: 0...3

Factory setting: 1



MED%: Antifreeze concentration (Vol-) %

When MEDT 0 or 3 is used, the parameter MED% is ,hidden'.

Adjustment range: 20...70

Factory setting: 45



kWh/MWh: Heat quantity

in kWh / MWh

Display channel



Heat quantity measurement is possible if a flowmeter is used. For this purpose, the heat quantity measurement option (**OHQM**) has to be enabled.

The flow rate should be read from the flowmeter (l/min) and has to be adjusted in the channel **FMAX**. Antifreeze type and concentration of the heat transfer medium have to be adjusted in the channels **MEDT** and **MED%**.

Antifreeze type:

0 : water

1 : propylene glycol

2 : ethylene glycol

3 : Tyfocor® LS / G-LS

The flow rate as well as the reference sensors S1 (flow) and S4 (return) are used for calculating the heat quantity supplied. It is shown in kWh in the channel **kWh** and in MWh in the channel **MWh**. The overall heat quantity results from the sum of both values.

The accumulated heat quantity can be reset. As soon as one of the display channels of the heat quantity is selected, the symbol **SET** is permanently shown on the display. Press button SET (3) for about 2 seconds in order to access the RESET mode of the counter. The display symbol **SET** will flash and the heat quantity value will be set to 0. In order to finish this process, press the **SET** button to confirm.

In order to interrupt the RESET process, no button should be pressed for about 5 seconds. The controller automatically returns to the display mode.

4.1.8 ΔT -regulation

DT O:

Switch-on temperature diff.
Adjustment range: 1,0...20,0 K
Factory setting: 6.0



This function is a standard differential control. If the switch-on differential is reached (**DT O**), the pump is operated. If the temperature difference falls below the adjusted switch-off temperature difference (**DT F**), the controller switches off.

DT F:

Switch-off temperature diff.
Adjustment range
0,5 ... 19,5 K
Factory setting 4.0 K

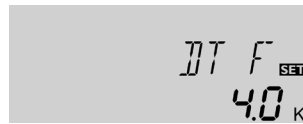

Please note: Switch-on temperature difference DO must be at least 1 K higher than the switch-off temperature-difference DF.

4.1.9 Maximum store temperature

S MX:

Maximum store temp.
Adjustment range: 2..95 °C
Factory setting: 60 °C



If the adjusted maximum temperature is exceeded, the store will no longer be loaded in order to avoid damage caused by overheating. If the maximum store temperature is exceeded,  will be shown.

Please note: The controller is equipped with a store emergency shutdown function, which prevents the store from being loaded when the store temperature exceeds 95 °C.

4.1.10 Collector emergency shutdown temperature

EM:

Collector emergency shutdown temperature
Adjustment range: 110 ... 200 °C
Factory setting: 140 °C



If the adjusted collector emergency shutdown temperature (**EM**) is exceeded, the controller will switch off the solar pump (R1) in order to protect the system against overheating (collector emergency shutdown). The factoring setting is 140 °C but it can be changed within the adjustment range of 110...200 °C. Δ (flashing) is displayed.

4.1.11 System cooling

OCX:

System cooling option
Adjustment range: OFF ... ON
Factory setting: OFF

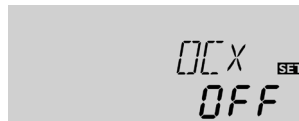

When the adjusted maximum store temperature is reached, the system stagnates. If the collector temperature increases to the adjusted maximum collector temperature (**CMX**), the solar pump is activated until the collector temperature falls below the maximum collector temperature. The store temperature may increase (subordinate active maximum store temperature), but only up to 95 °C (emergency shutdown of the store).

CMX:

Collector maximum temp.
Adjustment range: 100...190 °C
Factory setting: 120 °C



If OREC is additionally enabled:

If the store temperature is higher than the maximum store temperature (**SMX**) and if the collector temperature is at least 5 K below the store temperature, the solar system remains activated until the store is cooled down below the adjusted maximum temperature (**S MX**) via the collector and the pipework.

If the system cooling function is enabled, ☀ (flashing) is shown on the display. Due to the cooling function, the system will have a longer operation time on hot summer days and guarantees thermal relief of the collector field and the heat transfer fluid.

4.1.12 Minimum collector function

OCN:

Minimum collector function
Adjustment range: OFF / ON
Factory setting: OFF

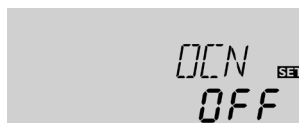

The minimum collector temperature is the minimum temperature which must be exceeded for the solar pump (R1) to switch on. The minimum temperature prevents the pump from being switched on too often at low collector temperatures. If the temperature falls below the minimum temperature, ☀ (flashing) is shown on the display.

CMN:

Minimum collector temperature
Adjustment range: 10 ... 90 °C
Factory setting: 10 °C



4.1.13 Antifreeze function

OCF:

Antifreeze function
Adjustment range: OFF / ON
Factory setting: OFF



The antifreeze function activates the loading circuit between the collector and the store when the temperature falls below the adjusted antifreeze temperature. This will protect the fluid against freezing or coagulating. If the adjusted antifreeze temperature is exceeded by 1 °C, the loading circuit will be deactivated.

CFR:

Antifreeze temperature
Adjustment range: -10 ... 10 °C
Factory setting: 4,0 °C



Please note:

Since this function uses the limited heat quantity of the store, the antifreeze function should be used in regions with few days of temperatures around the freezing point.

4.1.14 Recooling function

OREC:

recooling function option

Adjustment range:

OFF...ON

Factory setting: OFF



If the adjusted maximum store temperature (**S MX**) is reached, the controller keeps the solar pump running in order to prevent the collector from being overheated. The store temperature may increase but only up to 95 °C (emergency shutdown of the store).

The solar pump is switched on once the collector temperature is lower than the store temperature. It is switched off when the store is cooled down to the adjusted maximum temperature via the collector and the pipework.

4.1.15 Tube collector function

OTC:

Tube collector function

Adjustment range:

OFF...ON

Factory setting: OFF



If the controller detects an increase in collector temperature by 2 K compared to the previously stored collector temperature, the solar pump will be switched-on at 100 % for about 30 seconds in order to detect the fluid temperature. The current collector temperature will be saved as a new reference value. If the measured temperature (new reference value) is exceeded by 2 K, the solar pump will run for 30 seconds. If the switch-on difference between the collector and the store is exceeded during the runtime of the solar pump or the standstill of the system, the controller will automatically switch to solar loading.

If the collector temperature decreases by 2 K during standstill, the switch-on value for the tube collector function will be recalculated.

4.1.16 Thermostat function (Arr = 2)

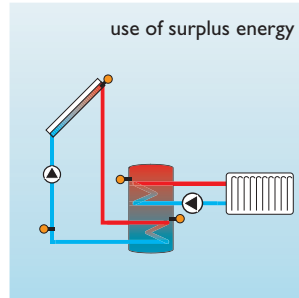
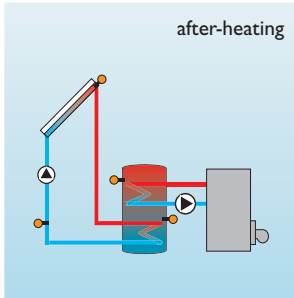

The thermostat function works independently from the solar operation and can be used for using surplus energy or for after-heating.

- **AH O < AH F**
thermostat function for after-heating
- **AH O > AH F**
thermostat function for using surplus energy

When the 2nd relay output is active,  is displayed.



AH O:
Thermostat-switch-on
temperature
Adjustment range:
0,0...95,0 °C
Factory setting: 40,0 °C



AH F:
Thermostat-switch-off
temperature
Adjustment range:
0,0...95,0 °C
Factory setting: 45,0 °C

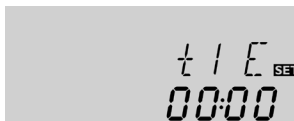

t1 E, t2 E, t3 E:
Thermostat switch-on time
Adjustment range:
00:00...23:45
Factory setting: 00:00

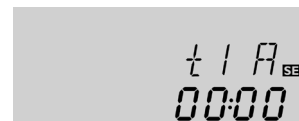

t1 A, t2 A, t3 A:
Thermostat switch-off time
Adjustment range:
00:00...23:45
Factory setting: 00:00

In order to block the thermostat function for a certain time span, there are 3 time frames t1 ...t3. If the function should be activated only between e.g. 6:00 and 9:00, 6:00 should be set for **t1 E** and 9:00 should be set for **t1 A**. The factory setting for the thermostat function is in continuous operation.



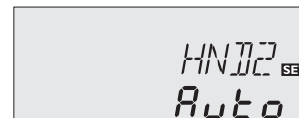
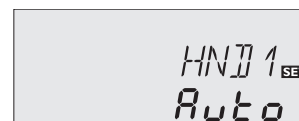

If all time frames should stop at 00:00 o' clock, the thermostat function is continuously in operation (factory setting).

4.1.17 Operating mode

HND1 / HND2:
Operating mode
Adjustment range:
OFF,AUTO,ON
Factory setting:AUTO



For control and service work, the operating mode of the controller can be manually adjusted. For this purpose, select the adjustment value HND1 / HND2. The following adjustments can be carried out:

- **HND1 / HND2**
Operating mode
OFF : relay off  (flashing) + 
AUTO : relay in automatic operation
ON : relay on  (flashing) + 

4.1.18 Language

LANG:
Language choice
Adjustment range:
dE, En, It, Fr
Factory setting: En



In this channel, different languages are available.

- dE : German
- En : English
- It : Italiano
- Fr : French

5. Troubleshooting

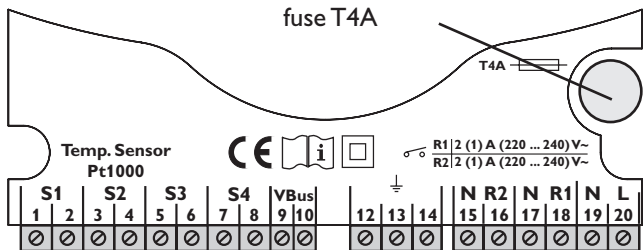

If a malfunction occurs, a message is displayed in the display of the controller:

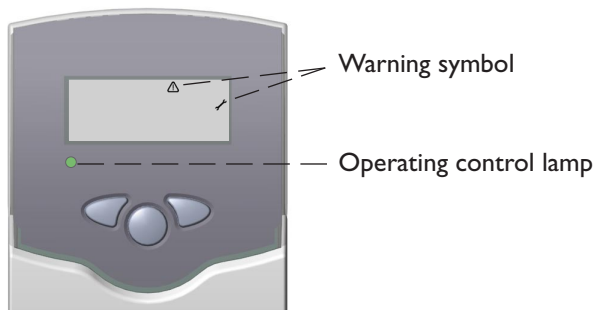

Operating control lamp flashes red. The symbol and the are shown.

Sensor fault. An error code instead of a temperature is shown on the sensor display channel.

888.8

- 88.8

Cable is broken. Check the cable.

Short-circuit. Check the cable.

Disconnected Pt1000 temperature sensors can be checked with an ohmmeter. In the following table, the resistance values corresponding to different temperatures are listed.

°C	Ω	°C	Ω
-10	961	55	1213
-5	980	60	1232
0	1000	65	1252
5	1019	70	1271
10	1039	75	1290
15	1058	80	1309
20	1078	85	1328
25	1097	90	1347
30	1117	95	1366
35	1136	100	1385
40	1155	105	1404
45	1175	110	1423
50	1194	115	1442

Resistance values of the Pt1000-sensors

Operating control lamp off

Check the power supply

o.k.

The fuse of the controller could be blown. It can be replaced after the front cover has been removed (spare fuse is enclosed in the accessory bag).

5.1 Various:

Pump is overheated, but no heat transfer from the collector to the store, flow and return have the same temperature; perhaps also bubble in the lines

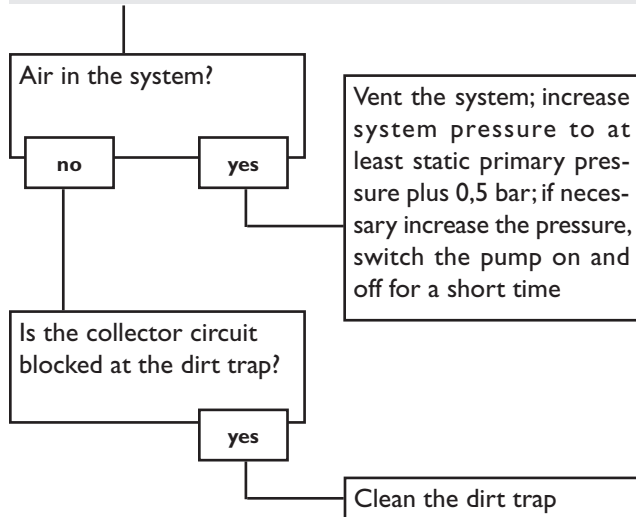

Pump starts for a short moment, switches-on/off again, etc.

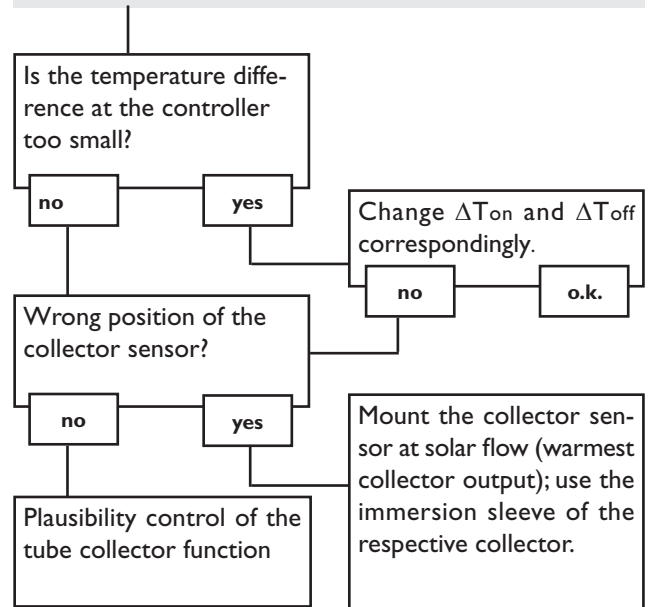

Pump starts up very late..

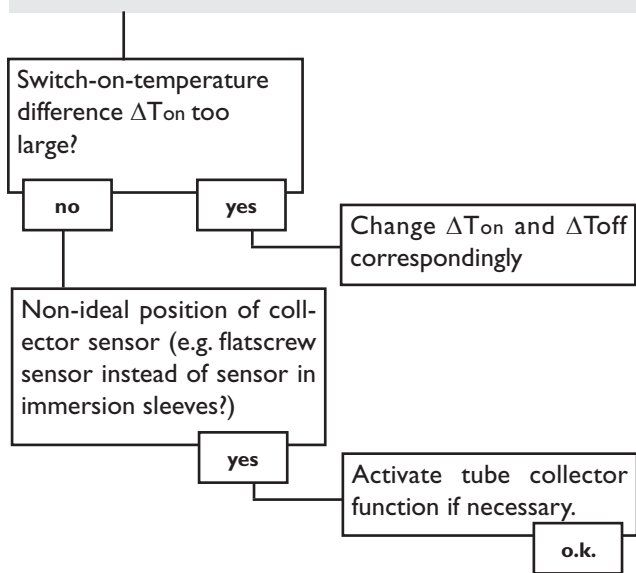

The temperature difference between the store and the collector increases enormously during operation; the collector circuit cannot divert the heat.

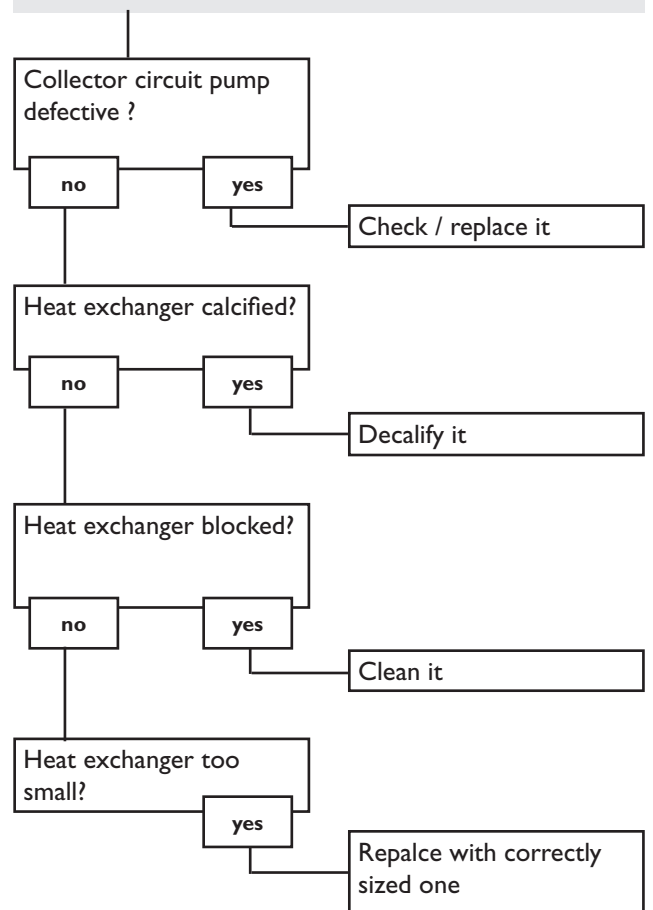

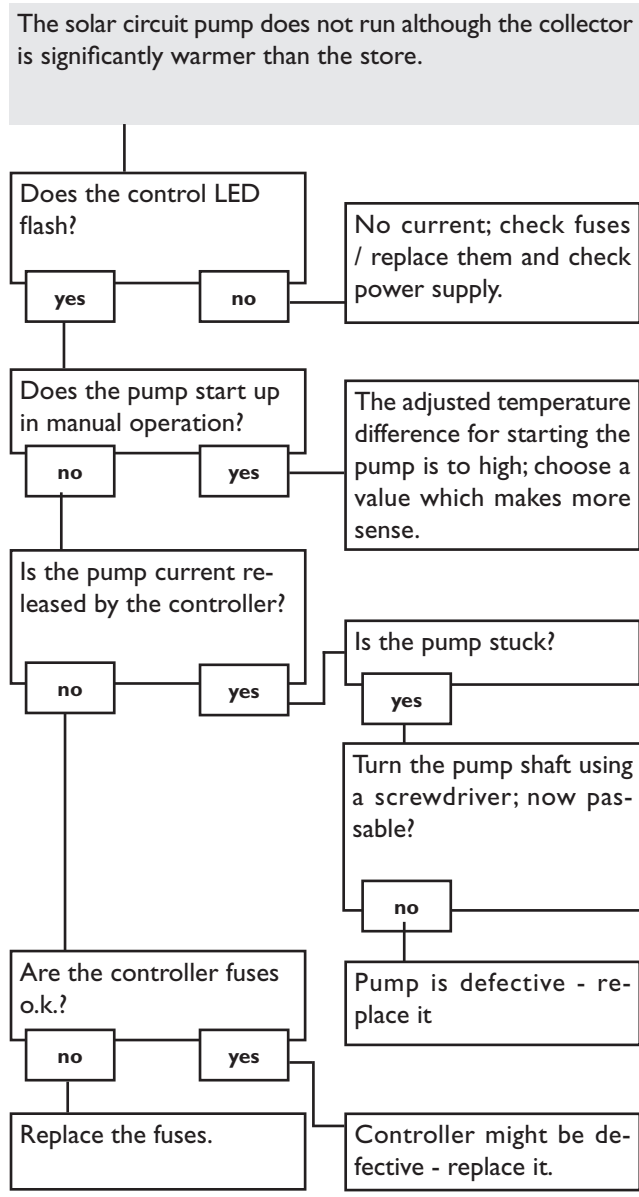
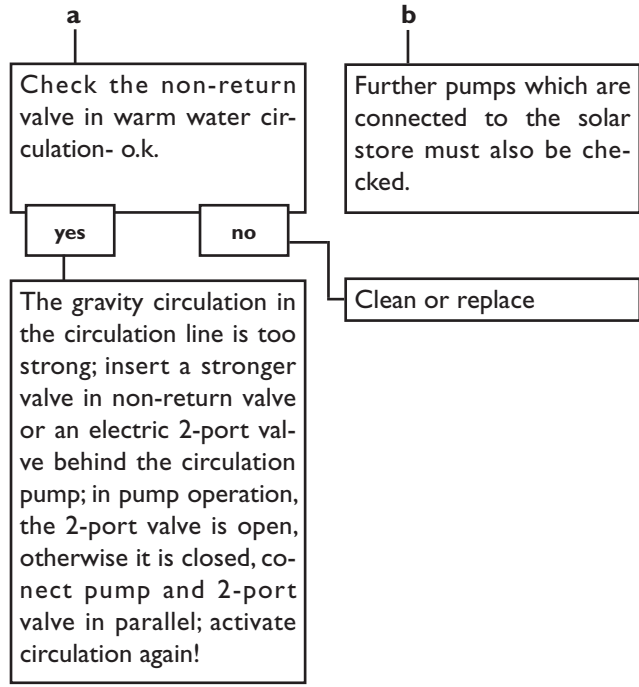
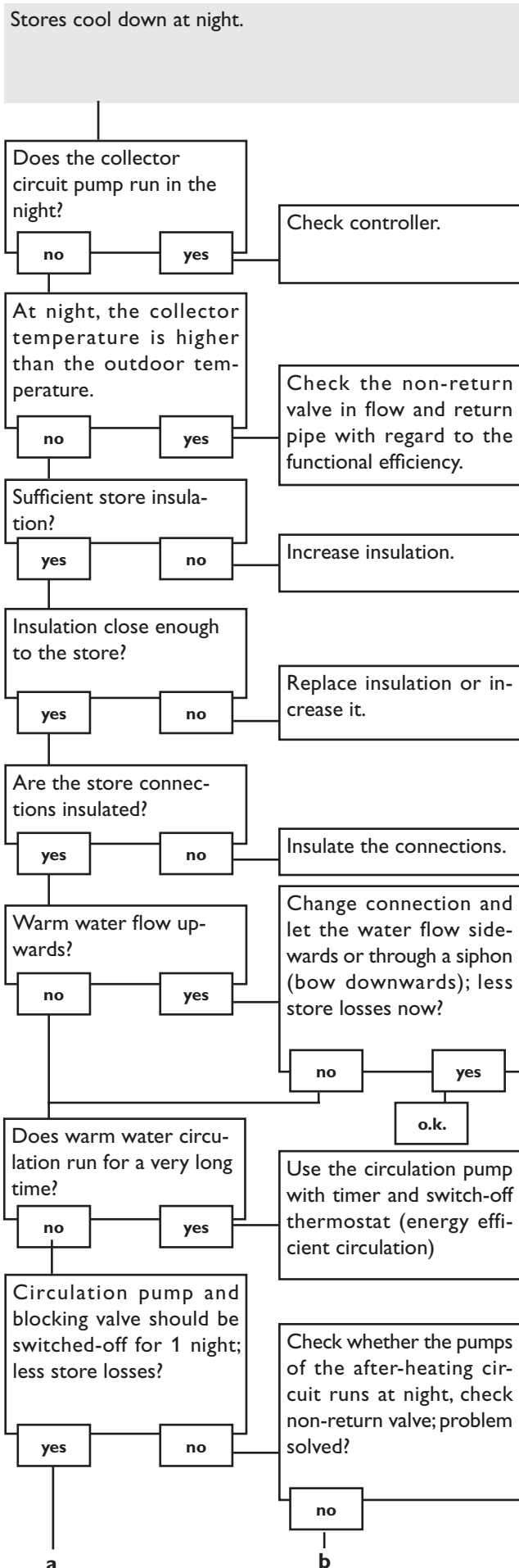

6. Accessory

Sensors

Our product range includes high-precision platinum temperature sensors, flatscrew sensors, outdoor temperature sensors, indoor temperature sensors, cylindrical clip-on sensors and irradiation sensors, also as complete sensors with immersion sleeve.



Flowmeter

If you wish to carry out a heat quantity measurement, you need a flowmeter for measuring the flow rate in your system.



Overvoltage protection device

In order to avoid overvoltage damage at collector sensors (e.g. caused by local lightning storms), we recommend installing the overvoltage protection RESOL SP1.



Smart Display SD3

The Smart Display SD3 is designed for simple connection to RESOL controllers via the RESOL VBus® for visualisation of the data issued by the controller: collector and store temperatures as well as energy yield of the solar system. The use of high-efficient LEDs and filter glass assures a high optical brilliance and good readability - even in poor visibility conditions and at a larger distance. An additional power supply is not required.



Notes

Notes

Distributed by:**RESOL - Elektronische Regelungen GmbH**

Heiskampstraße 10

45527 Hattingen / Germany

Tel.: +49 (0) 23 24 / 96 48 - 0

Fax: +49 (0) 23 24 / 96 48 - 755

www.resol.deinfo@resol.de**Important notice:**

We took a lot of care with the texts and drawings of this manual and to the best of our knowledge and consent. As faults can never be excluded, please note: Your own calculations and plans, under consideration of the current standards and DIN-directions should only be basis for your projects. We don't offer a guarantee for the completeness of the drawings and texts of this manual - they only represent some examples. They can only be used at your own risk. No liability is assumed for incorrect, incomplete or false information and / or any resulting damages.

Reprinting / copying

This mounting- and operation manual including all parts is copyrighted. Another use outside the copyright requires the approval of RESOL - Elektronische Regelungen GmbH. This especially applies for copies, translations, micro films and the storage into electronic systems.
Editor: RESOL - Elektronische Regelungen GmbH

Please note:

The design and the specifications can be changed without prior notice.
The illustrations may differ from the original product.